



◊ Körting ICE Condensation  
Vacuum System  
for edible oil applications

**Körting**

HANNOVER AG

THE  
**EJECTOR**  
COMPANY

# ICE Condensation Vacuum System

## In the today's market, Körting ICE Condensation Vacuum System make sense!

Like all vegetable oil processing vacuum systems, Körting ICE Condensation Vacuum Systems are able to operate an oil deodorising plant in the range between 1 - 4 mbar by extracting sparging steam and air.

In contrast to conventional vacuum systems, Körting ICE Condensation Vacuum Systems allow the process vapour to be condensed close to the operation pressure of the deodoriser (rather than having to compress it first with steam jet boosters then condense it to liquid). At a.m. pressures, condensation occurs between  $-20\text{ }^{\circ}\text{C}$  and  $-5\text{ }^{\circ}\text{C}$ , so in order to operate such condenser, a refrigerant to be circulated through its tubes at temperatures down to  $-30\text{ }^{\circ}\text{C}$  is required.

This results in the steam condensing as a solid ice coating outside of the condenser tubes. The ice layer has to be regularly removed by melting. In order to operate in a continuous cycle, Körting ICE Condensation Vacuum Systems utilise two parallel ice condensers which

are operated alternately. One ice condenser is in operation (being charged) whereas the other one is heated with hot water vapour to melt the ice layer.

At preset intervals, the clean, ice free condenser is pre-cooled before it is then switched back into the circuit whereas the other is disconnected to begin its melting cycle.

The sequence is designed in such a way that the vacuum level is not increased when switching over from one condenser to the other.



Assembly of an ice condensation block at site

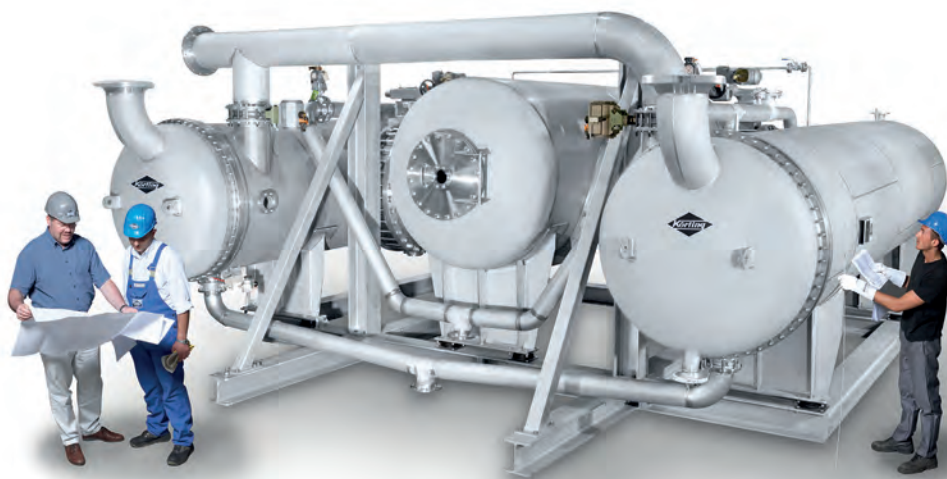

Ice condensation block completely assembled in the workshop



Ice condensation block completely installed at site

**Significant energy savings with virtually zero environmental pollution**

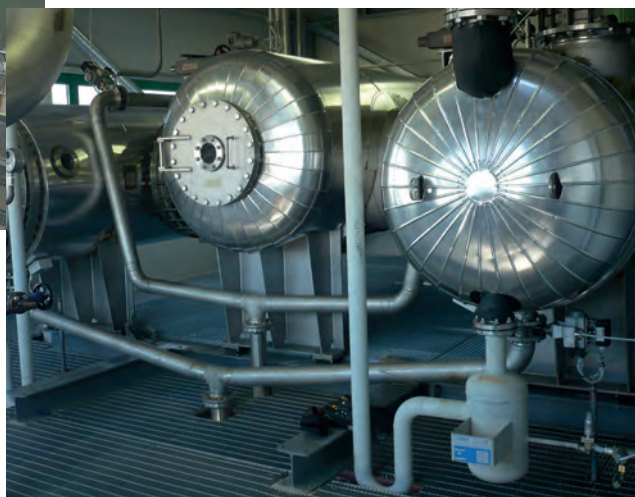

Front view of an ice condensation unit

## **Körting ICE Condensation Systems have two principle advantages:**

- The refrigerated coolant and the polluted sparging steam are strictly separated, which protects the environment considerably.
- The coolant compressor operates at a higher efficiency compared to steam jet boosters of a conventional vacuum system. Therefore, energy and operating costs are saved significantly.

The original concept was proposed by G. B. Martinenghi (1964) but at that time the high capital cost of the system compared to conventional vacuum systems proved uneconomical.

Today with increasing energy costs and strict environmental emission controls (waste water, air pollution), the ice condensation system is the most economic vacuum system for this application.

Körting ICE Condensation Vacuum Systems are based on many years of experience with a lot of installations world wide since 1988.

It is computer controlled and designed to be both:

**Simple and reliable in operation.**

# How do Körting ICE Condensation Vacuum System work?

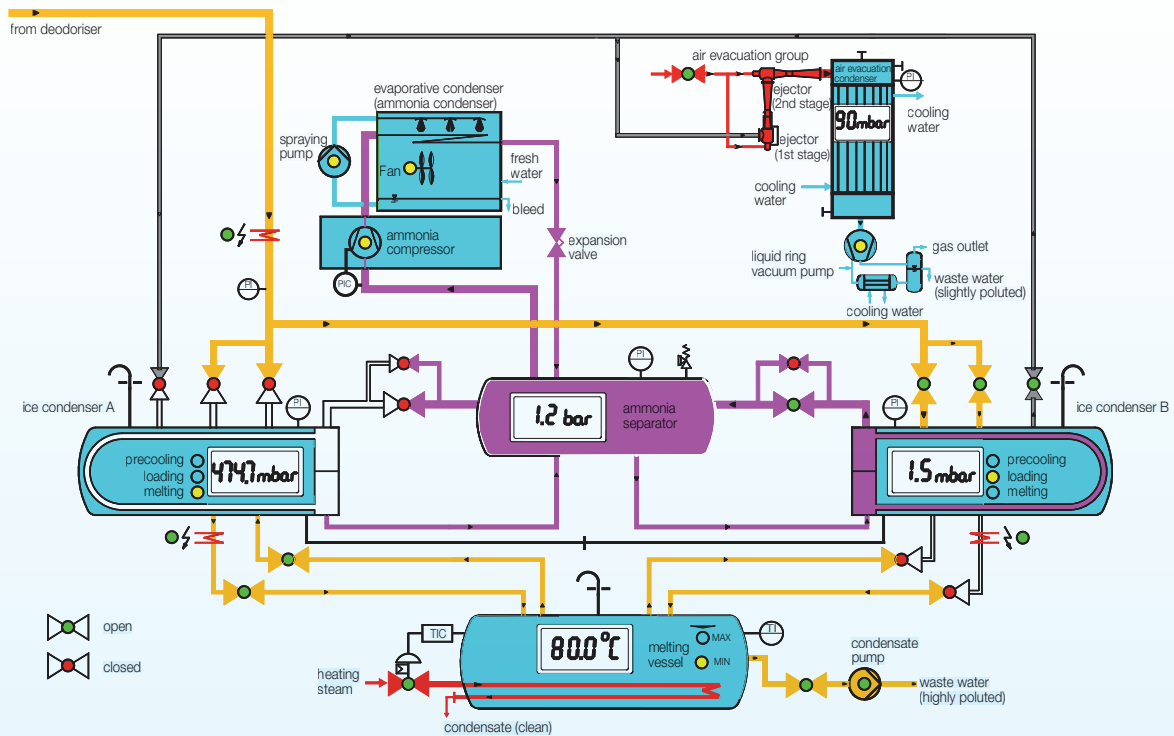

## Flow chart of an Körting ICE Condensation Vacuum System

The essential elements of the plant are illustrated in the figure above. In this example, ice condenser B is in use (being charged), ice condenser A is in its melting cycle.

### Condensing

The sparging steam from the deodoriser, polluted by fatty acids and other impurities and fatty substances, is alternately supplied to the ice condenser A or B. High performance butterfly valves are used to isolate the ice condenser from the process during melting. The condenser being charged is kept at low temperature by circulating the refrigerant through the tubes. The refrigerant is conveyed in a liquid state from the refrigerant separator and evaporated within the tubes of the condenser by absorbing of the condensation heat of the sparging steam. Typically, this process is regulated to produce surface temperatures of around  $-15\text{ }^{\circ}\text{C}$  to  $-25\text{ }^{\circ}\text{C}$  on the tubes.

This is below the condensation temperature of the sparging steam drawn from the deodoriser so the steam together with most of its impurities is condensed on the outside of the tubes as a coating of ice mixed with fatty crystals.

### Melting

After a loading time which, according to the design, may be between one and two hours the process flow is switched to the other ice condenser. The charged ice condenser (now with its cooling elements thoroughly coated with ice) is entirely separated from the deodoriser and heated to approx.  $60\text{ }^{\circ}\text{C}$  to  $80\text{ }^{\circ}\text{C}$  with vapour originating from the polluted condensate in the heated melting vessel. The molten ice which is a mixture of water, oil and fatty substances runs off from the tubes and back into the melting vessel.

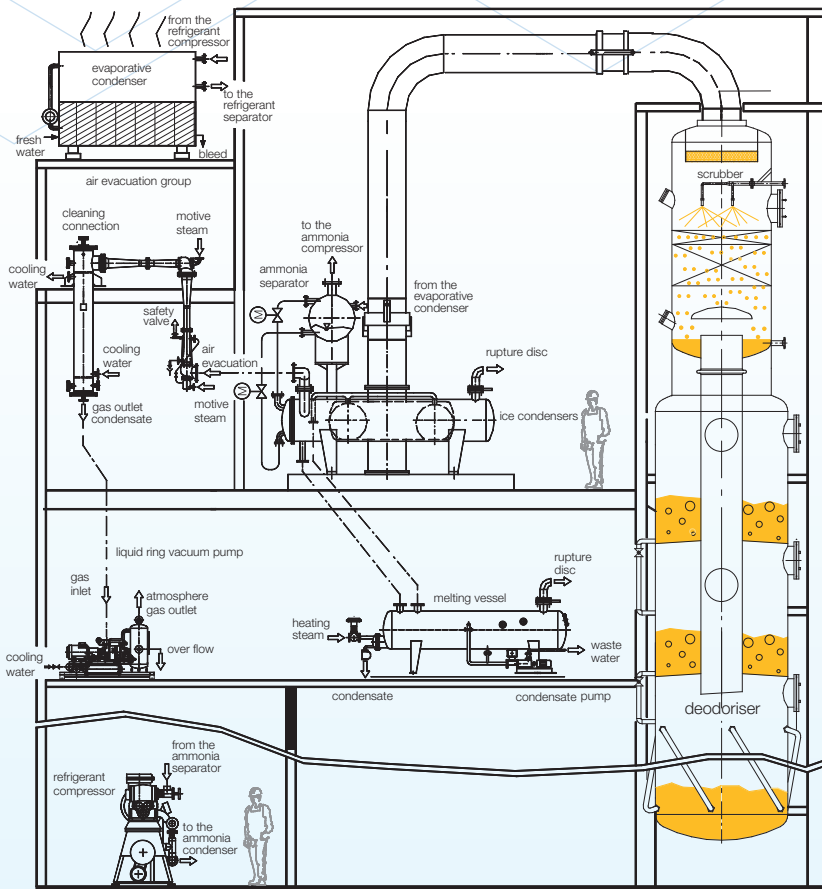

Typical installation of an ICE Condensation Vacuum System at an oil deodorising column

### Condensate discharge

The surplus liquid from the melting vessel which contains most of the impurities of the original sparging steam is discharged from the melting vessel by a condensate pump.

### Steam jet ejectors

In order to evacuate all non-condensables from the ice condensers, a small 2-stage steam jet ejector vacuum group combined with a liquid ring vacuum pump is used. Cooling water for the interconnected small surface condenser as well as ejectors and the liquid ring vacuum pump will be kept clean. Only the small amount of condensate leaving the small surface condenser is slightly polluted and will leave the system at the separator of the liquid ring vacuum pump. At this point the exhausted gas of the process is also discharged to the atmosphere.

### Coolant refrigeration

To minimise the maintenance costs and for high operating reliability, the Körting ice condensation vacuum system operates with twin-shaft screw compressors (refrigerant compressor).



2-stage steam jet vacuum ejectors with shell and tube condenser

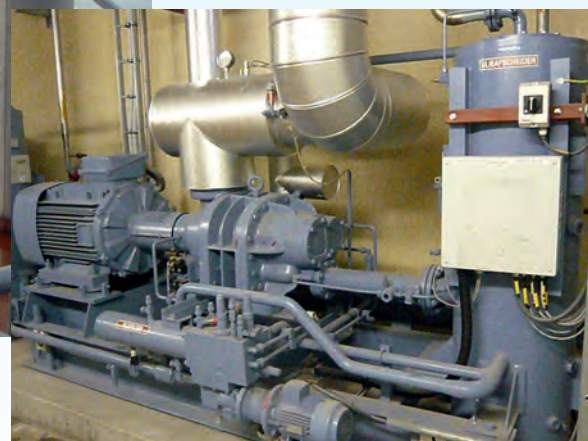

Screw compressor for refrigeration

## Why do Körting ICE Condensation Vacuum Systems produce virtually zero environmental pollution?



Melting vessel of a Körting ICE Condensation Vacuum System

Körting ICE Condensation Vacuum Systems produce nearly no pollutants. This is principally based on the fact that the cooling water is kept strictly separated from the condensate of the polluted sparge steam.

As condensation takes place at low temperature and at the pressure level in the deodoriser, the melted condensate flowing from ice condenser A and B is undiluted and highly concentrated (almost 100 % of the high-boiling oil components, i.e. fatty acids, which are exhausted during deodorisation can be found in condensate).

Only some low-boiling substances such as aldehydes and ketones are exhausted from the ice condensers by the steam jet ejectors together with the non-condensable gas.

The motive flow of the ejectors as well as the condensable parts of the suction flow are condensed in a downstream surface condenser. There is no contact with the cooling water.

For the atmospheric stage of the air evacuation unit, a liquid ring vacuum pump is used. To remove the condensation and compression heat, the service water (polluted with low-boiling oil substances) is passed through a heat exchanger in a closed loop so that no oil substances may enter the cooling water.

Non condensable gases from the process and the leakage air, which enters the deodoriser, is polluted with low-boiling oil substances. This gas mixture is the only exhaust flow discharged from the unit by means of the liquid ring vacuum pump via the liquid separator. This exhaust gas can be treated by combustion in a steam boiler or in a biological filter plant.

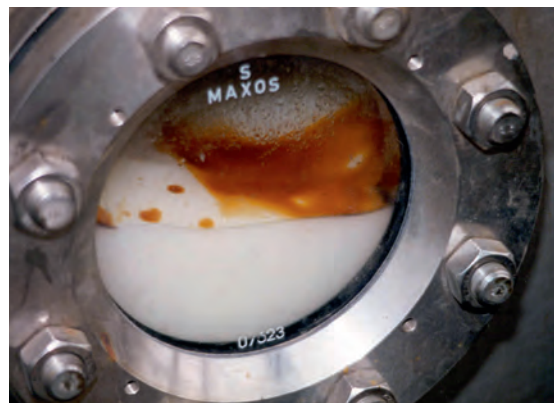

Molten condensate in the melting vessel

Mechanical vacuum pumps (roots blowers) can be used instead of the steam jet vacuum ejectors. However, this is generally not recommended because mechanical pumps are much more susceptible to failures.

## Körting ICE Condensation Vacuum Systems save money!

The comparison between a Körting ICE Condensation Vacuum System and a conventional steam jet vacuum ejector system as well as the operating costs depend on two principal factors:

- Based on standard specific costs for steam and electricity the total operating costs for a Körting ICE Condensation Vacuum System are much lower compared to a conventional steam jet vacuum system.
- Investment costs are higher – Körting ICE Condensation Vacuum Systems require higher initial investment compared to other vacuum producing equipments used in the processing of edible oils and fats but they offer a short payback time.

The figure below illustrates the typical payback time for the investment of a Körting ICE Condensation Vacuum System compared to a steam jet vacuum ejector system with direct contact condensation. The graph is calculated for a condensation pressure of 1.5 mbar which corresponds to a deodoriser pressure of around 2.5 mbar and a cooling water inlet temperature of max. 33 °C. The graph shows that the payback time depends on the oil production

capacity, based on fixed prices for steam, electricity, cooling water and waste water. The bigger the oil production capacity (the higher the condensation rate of the ice condensation vacuum system), the shorter the payback time. If the steam price (for motive steam of the comparable steam jet vacuum ejector system) is high, the payback time of the Körting ICE Condensation Vacuum System will be considerably reduced.

### Example

For an oil production capacity of 600 tons/day and a motive steam price of 25 Euro/ton, electric power of 0.1 Euro/kWh and waste water costs of 4.0 Euro/m<sup>3</sup> the additional costs of purchasing a Körting ICE Condensation Vacuum System compared to a conventional steam jet vacuum system can be expected to be recovered in about 3 years. After that time the system is saving money.

N. B. payback time are based on the ex-works price excluding installation and commissioning.

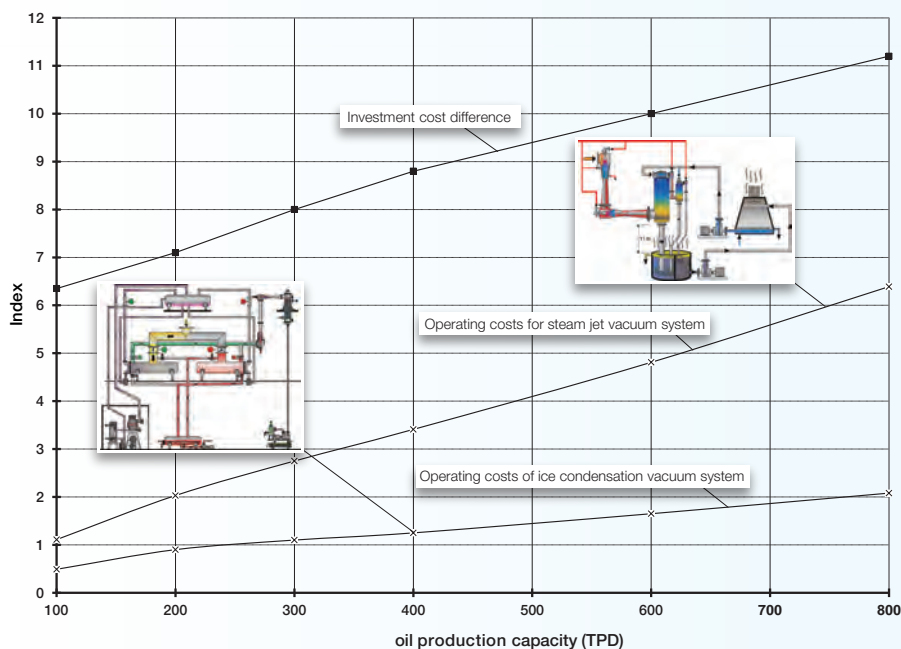

Example (600 tons/day)	Index
Steam jet vacuum system with waste water	→ 4.8
Körting ICE Condensation Vacuum System	→ 1.6
Investment cost difference	→ 10.0
Payback time $10.0 / (4.8 - 1.6) = 10 / 3.2$	3.1 years



FED s.r.l.

Via dei Valtorta, 2  
20127 MILANO  
Italy

Tel.: +39 02 26826332

Fax: +39 02 26140150

E-Mail: [fed@fed.it](mailto:fed@fed.it)

[www.fed.it](http://www.fed.it)