



Körting ejector technology

for the shipbuilding industry



Ejector technology on-board ships

With more than 140 years of experience in the field of ejector technology, Körting Hannover AG supplies highly efficient and reliable solutions for the shipbuilding industry. Körting ejectors are used in a broad variety of shipbuilding applications wherever low investment costs, simplicity in design, maintenance-free operation and reliability are important.

Practical use

Ejectors are self-priming fluidic apparatuses used for suction, pumping, evacuating, mixing or discharge of liquids, gases, vapours or solids. They are driven by liquids, gases or vapours, so ejectors do not have any electrical or mechanical drive unit, dynamic gaskets or any moving parts. Therefore they are relatively insusceptible to soiling and absolutely safe against dry running.

On-board ships ejectors are mainly tried and tested as bilge and ballast ejectors. They can be utilised for the ballast tanks, the bilges, the engine room, the chain lockers, the bow thrusters, the cofferdams, the forepeak etc. Ejectors are also used in handling grey or black water.

All Körting ejectors are customised according to the actually required performance data. The individual design qualifies us to find solutions even for extremely special requirements; in other words our ejectors will be designed exactly for your field of application. An extensive unit assembly system enables us also to customise our ejectors for all standard connection types. By using high quality materials Körting ejectors are fully resistant to the chemical attack of any medium. Our ejec-

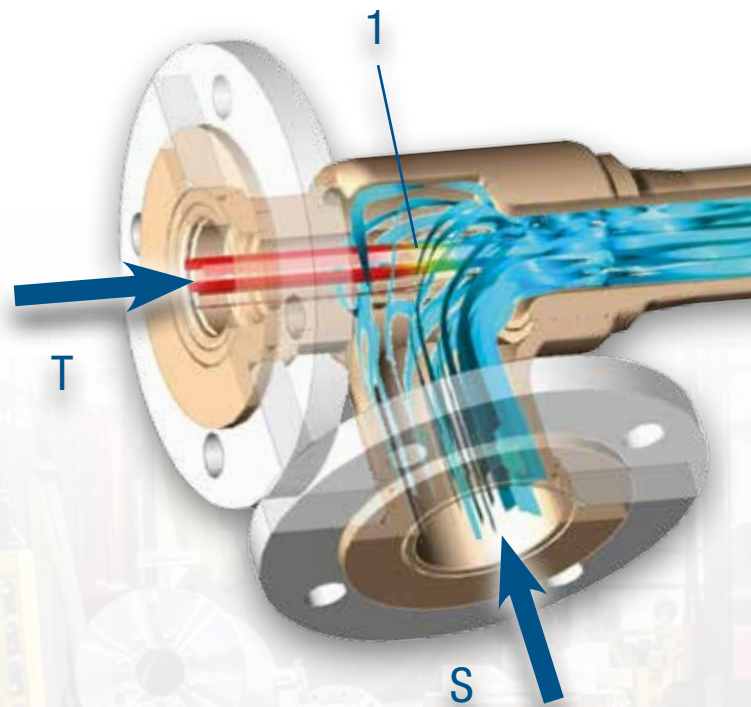

tors rarely need maintenance and they are ready for use at any time.

Low investment costs, a customised design and maintenance-free operation should be essential arguments for all shipping companies and ship designers in order to reduce operating costs and to ensure 100 % availability of the system. A customised bilge ejector means that the connecting pipe system can be ideally adapted to also reduce costs in the environment of the bilge ejector which includes parts such as piping, valves, fittings and other. A project-related design free of cavitation ensures durability and finally a Körting ejector may last for the ship's lifetime. It is always worth paying more attention to the design of the ejectors, particularly when it comes to weight-saving and consequently to a reduction in the energy consumption of the bilge ejector itself.

Körting Hannover AG is the leading company of ejector technology in shipbuilding industry and at the same time the oldest manufacturer of ejectors at all. Our longstanding experience in manufacturing and a continuous R&D are the basics of our success.

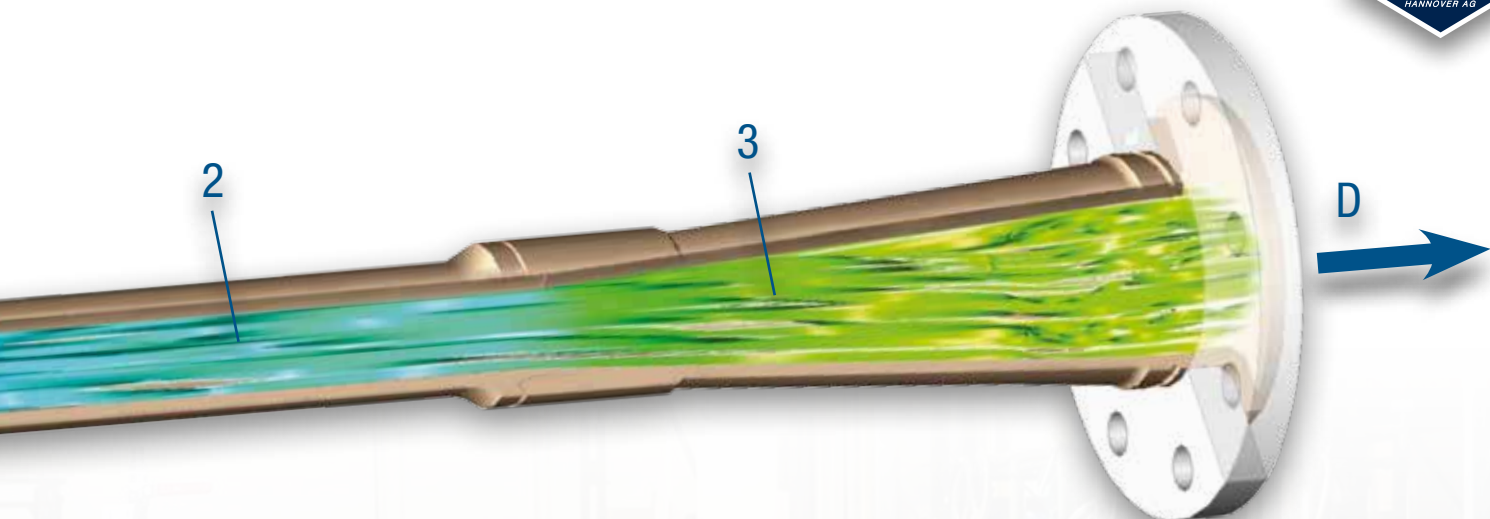

Physical process

Static pressure at the inlet of an ejector is converted into kinetic energy and this again back into static pressure at the outlet. As a result a low pressure section in the ejec-

tor creates a suction effect. The difference between the low pressure and the static pressure at the outlet describes the delivery head of an ejector.

How it works

The functionality of water jet bilge ejectors is solely based on fluid dynamics. Sea water from the ships own FiFi or ballast system is introduced under pressure into the motive connection (T) of the ejector. The motive nozzle (1) converts the static pressure into high velocity. As a result a defined low pressure section is formed downstream of the motive nozzle (1).

The suction flow can be sucked in through the suction connections (S). Motive and suction flow intermix at the inlet of the mixing passage (2) by means of impulse exchange. Subsequently the velocity of the mixed flow decelerates in the diffuser (3). The kinetic energy of the mixed flow is converted into static

pressure at the outlet of the ejector (D) again. Drawn to a curve the velocity and pressure gradient along an ejector would be almost contrary. That means that an increase of the flow velocity inside will result in a decrease of the system pressure and vice versa. The velocity gradient inside an ejector from red (high velocity) to green (low velocity) is illustrated in the figure above.

This abstract may give you an idea of the functionality of an ejector. However, the efficiency is always hidden in the detail. Only a customised design for the particular field of application affords the opportunity to save costs and energy.



The best solution for your individual application

Körting Hannover AG designs, manufactures and supplies a wide range of ejectors, regardless of the field of application or which material quality or design will be required.

Pumping liquids

Liquid jet liquid ejectors, used for bilging, stripping or ballasting of bilges, ballast tanks, engine rooms, chain lockers, bow thrusters, cofferdams, forepeaks, etc.

Conveying solids

Liquid or gas jet liquid ejectors, used to convey solids like filter material, sand grit, gravel, powders, etc. or to mix suspensions in offshore technology.

Compressing gases

Liquid jet gas compressors, used for the aeration and intermixing in biological sewage water treatment plants.

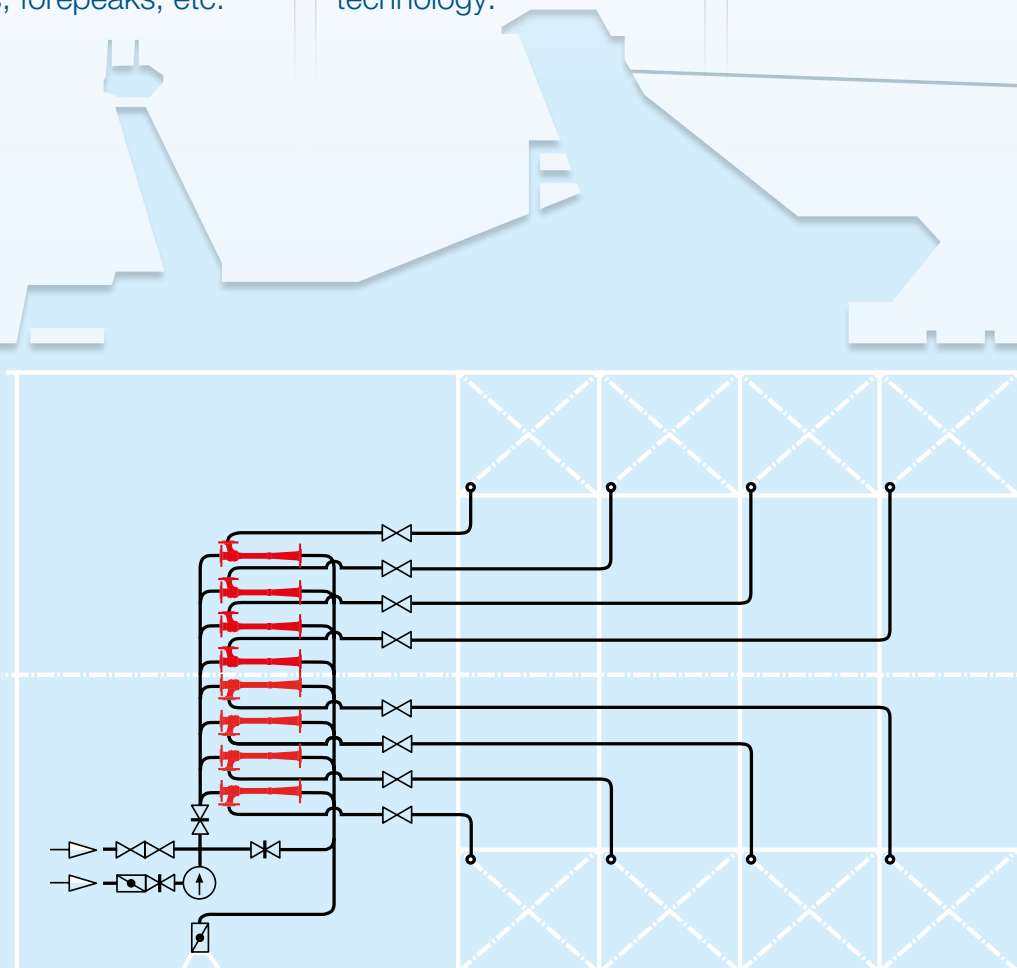



Heating liquids

Steam jet liquid heaters, used for the heating of liquids. These special types of heaters serve e.g. for the operation of sea water evaporators or for the heating of wash water.

Ventilating

Liquid jet ventilators, used to ventilate void spaces and cargo holds or to draw off CO₂ gases in an emergency.

Evacuating

Liquid, gas or steam jet vacuum ejectors, used to evacuate all kinds of technical systems. These ejectors serve e.g. for degassing on dredgers or for starting up evacuation of mechanical pumps.

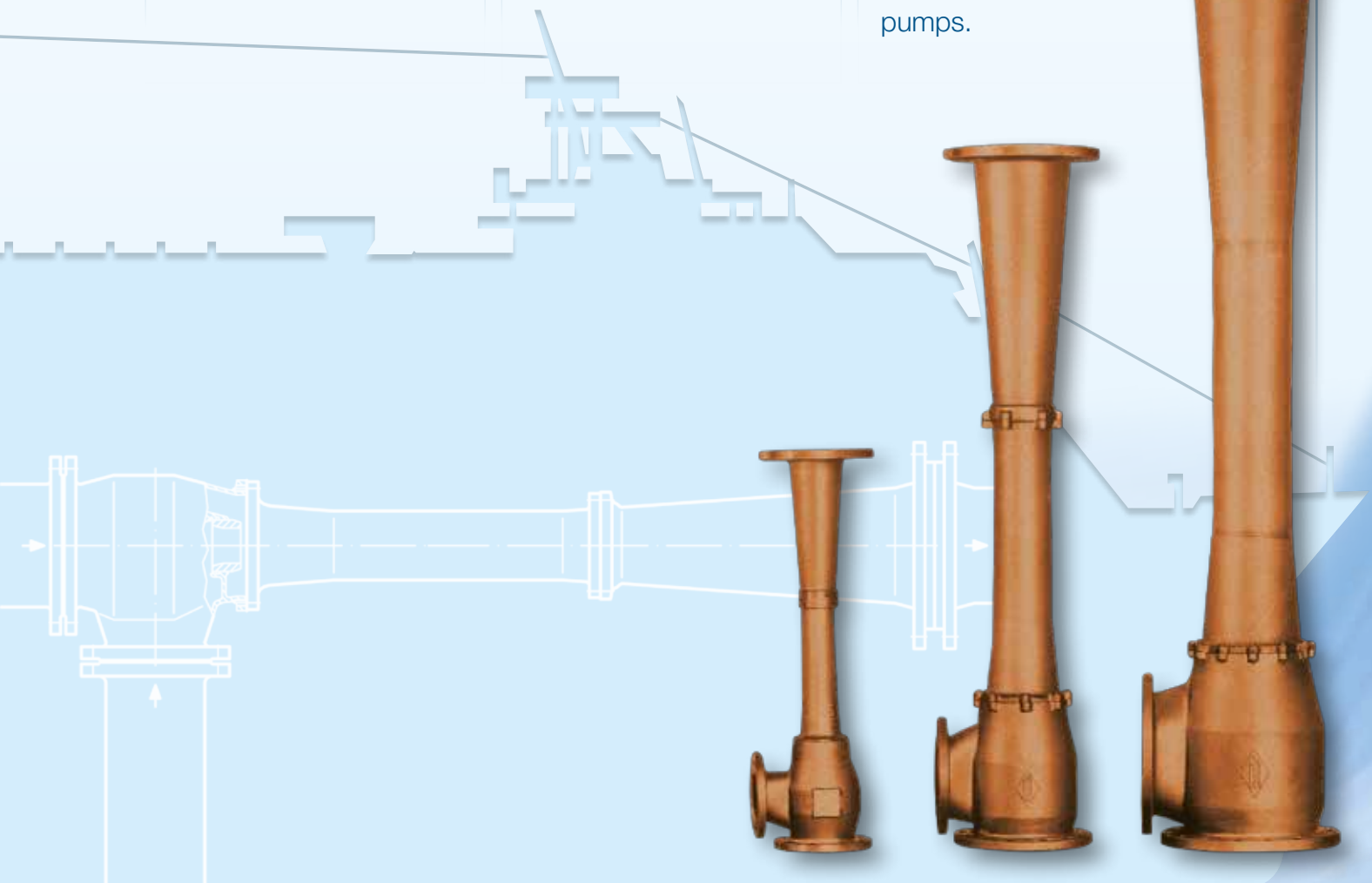

Specific advantages of Körting water jet bilge ejectors

Design, R&D and manufacturing in Hannover

Design, R&D and manufacturing of our ejectors are solely done at our plant at the headquarters in Hannover, Germany. Therefore, a close alliance between theory and practice is guaranteed. It enables us to realise even unconventional technical solutions within shortest time.

Project-related design

The individual design of our ejectors results in minimised energy consumption at maximum suction performance. Consequently our ejectors will be designed for the most effective size. A customised bilge ejector means that the connecting pipe system can be ideally adapted to also reduce costs in the environment of the bilge ejector which includes parts such as piping, valves, fittings and other.

Comprehensive service on-site

Our agents abroad and our project engineers are at your disposal at any time:

- during tendering / project planning
- during design / manufacturing / inspection
- during order processing
- after-sales service

Operation without cavitation

The customised design of our ejectors enables an operation at a low noise level without any cavitation within the full range of the specified performance data.

Optional flange design

In order to facilitate the assembly our standard ejectors are fitted with loose flanges. The counter flanges on the part of the pipe system do not have to be adjusted. The flange dimensions can be drilled according to EN, ASME, JIS, VG or any other flange standard.

Recognised by all known shipping companies

Körting bilge ejectors have been strongly linked with the shipbuilding industry since 1871. The following ships are deemed to be our oldest references:

- The worldwide oldest paddle steamer, the "HJELEN". She is registered in Silkeborg and has been in constant service since 1892.
- The worldwide oldest seagoing passenger ship with a coal-fired steam boiler, the steamship "SCHAARHÖRN". She is registered in Hamburg and has been in constant service since 1908.

Optional connection types

Our extensive unit assembly system enables us to adjust our ejectors in any required way. Among others our product range includes thread connections, hose couplings like Storz, Guillmin, etc. or straight pipe ends for quick couplings like Straub-Grip, Norma, etc.

Choice of material quality

For economical reasons our standard ejectors are made of sea water resistant cast bronze (CC480K/CC483K) or alternatively cast iron (GJS/GJL). However, in case of special requirements we can supply special designs in any other material quality.





Korean Register of Shipping



American Bureau of Shipping (ABS)



Lloyds Register (LR)



U.S. Coast Guard (USCG)



Nippon Kaiji Kyokai (Class NK)



Germanischer Lloyd



Registro Italiano Navele (RINA)



Bureau Veritas (BV)



Det Norske Veritas (DNV)



China Classification Society

High material quality standard

Our ejectors are made of high quality cast bronze materials (CC480K/CC483K) which are fully resistant against the chemical attack of sea water. Moreover these materials provide highest strength characteristics with low weight.



The outstanding properties of these materials are also recorded by several shock and vibration tests and even blasting tests which have been carried out for military projects.

Extensive documentation

Our documentation includes detailed operating instructions, technical specifications, performance curves, assembly drawings as well as work's specific test reports. Furthermore any special requirement by the shipyard or a certification body can be taken into consideration.

Extensive stock

A sophisticated unit assembly system ensures long-term delivery service for all of our ejectors. To that effect our extensive supplies of spare parts enables shortest possible delivery times for all spares.

Support for ship designers

In order to support your piping design department during the project planning technical data sheets as PDF-file and 3D wire frame models as DXF-file can be supplied.

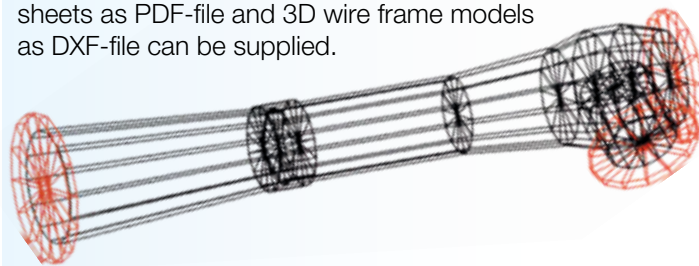

Final inspections

After completion all of our ejectors are subjected to an extensive final inspection, including general visual examination, dimensional checking as well as hydrostatic pressure testing.

At the customer's request performance tests of the actual operating conditions or recordings of special characteristic curves and various other tests can be performed before shipping takes place.

If required all tests and examinations can be carried out under survey of any official authority or classification society.

Classification

Our ejectors are built in order to fulfil the specific requirements of the shipbuilding industry. This of course includes full compliance with the rules and regulations of all recognized classification societies like GL, DNV, BV, LR, ABS, RMRS, KR, and others.

Körting ejector types

Design and material of an ejector are determined by its different operating conditions and a diversity of media respectively. Our extensive unit assembly system enables us to meet all these requirements. A summary of our standard ejector types is given below.

Ejector type "L"

- bilge and ballast ejectors for stationary applications
- loose flanges drilled acc. to EN, ASME, JIS, VG or others.
- motive connection in axial direction of the outlet
- lateral suction connection
- nominal sizes from DN 20 to DN 200

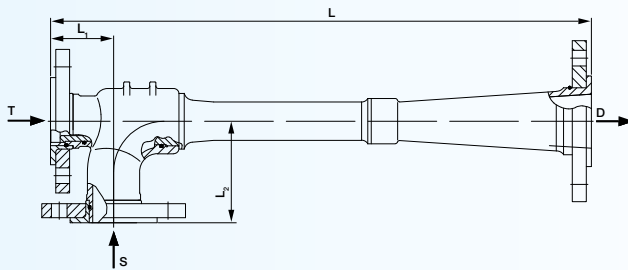

Connection dimensions			Main dimensions		
D	T	S	L	L1	L2
20	15	20	235	65	75
25	20	25	281	70	85
32	25	32	354	75	95
40	32	40	427	85	101
50	40	50	525	95	101
65	50	50	620	70	115
80	65	65	765	85	125
100	80	80	948	108	140
125	100	100	1205	140	150
150	125	125	1440	160	170
200	150	150	1835	160	180

Ejector type "S"

- bilge and ballast ejectors for stationary applications
- loose flanges drilled acc. to EN, ASME, JIS, VG, etc.
- suction connection in axial direction of the outlet
- lateral motive connection
- nominal sizes from DN 40 to DN 500

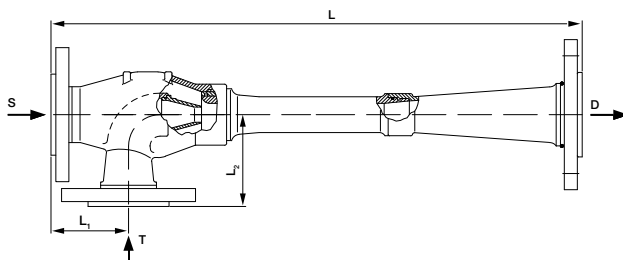

Connection dimensions			Main dimensions		
D	T	S	L	L1	L2
40	40	50	496	101	100
50	40	50	577	101	100
65	65	65	710	105	125
80	65	65	840	105	125
100	100	100	1075	130	150
125	100	100	1285	130	150
150	150	150	1585	155	205
200	150	150	1983	155	205
250	200	200	1885	205	250
300	250	250	2347	275	330
350	300	300	2827	345	380

Ejector type "T"

- bilge ejectors for stationary applications
- thread connections
- motive connection in axial direction of the outlet
- lateral suction connection
- standard sizes from G 3/4" to G 2"

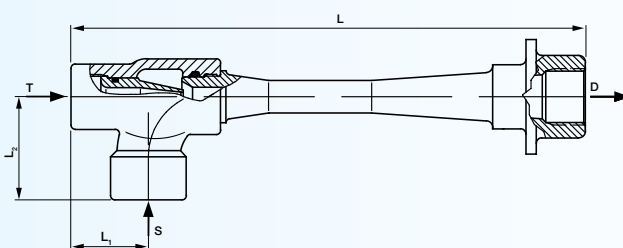

Connection dimensions			Main dimensions		
D	T	S	L	L1	L2
G 3/4	G 1/2	G 3/4	235	40	50
G 1	G 3/4	G 1	281	45	60
G 1 1/4	G 1	G 1 1/4	360	50	70
G 1 1/2	G 1 1/4	G 1 1/2	430	60	75
G 2	G 1 1/2	G 2	530	70	75

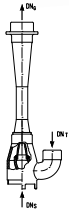
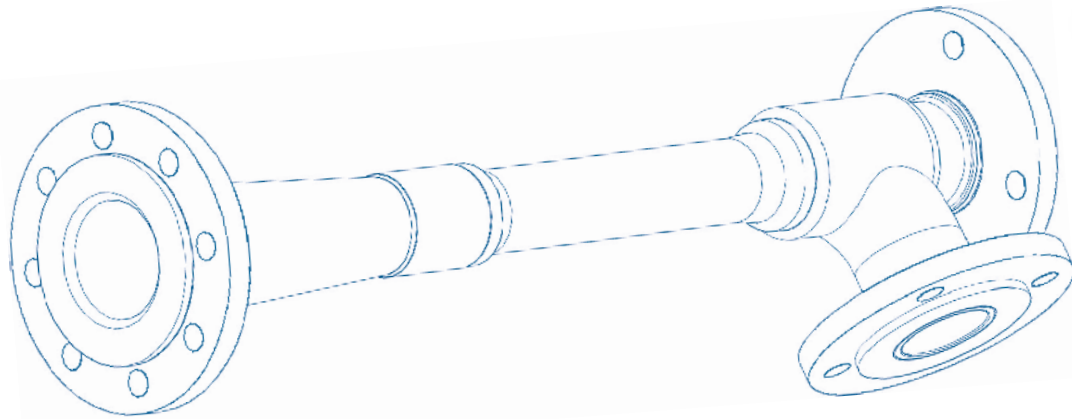

Ejector type "P"

- bilge ejectors for mobile and stationary applications
- thread connection (with hose couplings on request)
- suction connection in axial direction of the outlet
- lateral motive connection
- standard size G 2"

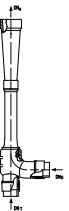

Ejector type "Q"

- bilge and ballast ejectors for stationary applications
- straight pipe ends for quick coupling systems (Straub-grip, Norma, etc.)
- motive connection in axial direction of the discharge side
- lateral suction connection
- nominal sizes from DN 20 to DN 200

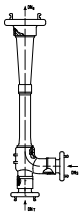

Ejector type "H"

- portable bilge ejectors for mobile applications
- fitted with hose couplings (Storz, Guillin, etc.)
- motive connection in axial direction of the outlet
- lateral suction connection
- nominal sizes from DN 25 to DN 150

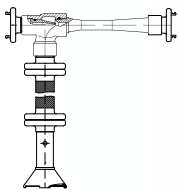

Ejector type "D"

- bilge ejectors for mobile and stationary applications
- various connection types (thread, flange, couplings, etc.)
- special suction intake system to overcome heights of more than 9 m up to 30 m
- motive connection in axial direction of the outlet
- lateral suction connection

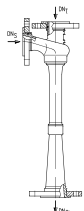

Ejector type "V"

- liquid jet vacuum ejectors for stationary applications
- loose flanges drilled acc. to EN, ASME, JIS, VG or others.
- motive connection in axial direction of the outlet
- lateral suction connection
- nominal sizes from DN 20 to DN 200

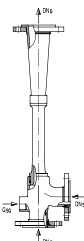

Ejector type "VL"

- tandem jet ejectors for stationary application on sea water evaporators
- combined function for evacuating and removal of brine
- loose flanges drilled acc. to EN, ASME, JIS or others
- motive connection in axial direction of the outlet
- two lateral suction connections
- nominal sizes from DN 20 to DN 150

The efficiency's in the details

Let's have a closer look at the main area where ejectors are used in shipbuilding. Bilge ejectors are fluidic devices without mechanical drives, dynamic gaskets or any moving parts. Therefore, they are not subjected to mechanical wear, require no maintenance and dry running isn't possible. Even an operation free of cavitation can be ensured if a design is project related. The functionality of self-priming bilge ejectors is solely based on fluid dynamics, driven by water supplied by the mechanical pumps from the ship's own system. In order to achieve optimum efficiency, the design of a bilge ejector should always be based on the performance data at the design point. The effective pressure data in relation to the connections must be taken into consideration.

How to avoid mistakes when designing bilge ejectors

A frequent mistake in technical specifications is to treat bilge ejectors in the same way as mechanical pumps. This ignores the fact that the behaviour of the performance curves of bilge ejectors and mechanical pumps is totally different. The design of an ejector always depends on the motive pressure related to

the suction pressure and the discharge pressure. Nevertheless, you will find a number of vendors dealing with ejectors by catalogue. Therefore, you need to ensure you receive a quote for bilge ejectors with a constant total manometric head only.

Lower the operating costs

The standardisation of bilge ejectors has an adverse affect and results in a loss of efficiency. On the other hand, detailed planning at an early stage leads to lower investment and operating costs. However, when selecting a bilge ejector the necessary drive energy and consequently the right mechanical pump should be taken into consideration. The wrong choice in this context, based on the pure investment costs only, could lead to higher operating expenses during the whole life time.

**The efficiency's in the details.
Ask the experts at Körting
Hannover AG for further support.**



Calling all buyers

When designing jet ejectors for the shipbuilding industry, Körting Hannover AG profits from decades of experience. Only superior quality materials and components are used which are destined to be durable and very reliable. Today you benefit from performance-enhanced jet ejectors and less time spent on maintenance and repair.

Ask us about the quote

If financial reasons expect you to use other materials, or if the nominal width is different, or if your requirements differ from our quote, please contact us directly.

In some cases, these factors could be enhanced to produce a more attractive quote. To do so, after the quote has been drawn up, the application needs to be looked at separately again. Our experts would be happy to point any efficiency options. Take advantage of direct contact and approach us. We'll find the best solution together.



Typical installations



FED s.r.l.

Via dei Valtorta, 2
20127 MILANO
Italy

Tel.: +39 02 26826332

Fax: +39 02 26140150

E-mail: fed@fed.it

www.fed.it